

Version 2.2

K Series

ViiPOWER®

Precision DC Power Supply

Model AK User's Manual



Suite #504, HanShin S meca, 65, Techno 3-ro, Yuseong-gu, Daejeon, Korea
YuSung-ku, Daejeon 34016, ROK(Republic of Korea)
Tel: 82+42 934 6928 Fax: 82+42 934 6927
[Http://www.vupower.com](http://www.vupower.com) e-mail: sales@vupower.com

Please Read Before Operation.

For the User of this Product

It is advisable for the user of this unit to have thorough understanding of the contents of this user guide and electrical knowledge for the proper operation of this product.

AC Input Power

Please check the following key points prior to installation and operation of this product. Make sure that the AC input plug is identical to the drawing below. AC input plug must have a ground terminal connected to the unit.



Earth (Ground) Terminal

If the ground terminal is not connected to the unit from the AC power source outlet, the unit feature may not function properly. Please use the AC power cable included in the package with this product. If unavoidably the user needs to use a different cable, please make sure to use cables with minimum rate capacity of 250V 7A

Maintenance and Inspection

Make sure to unplug the AC power cable prior to performing maintenance and inspection. Consult with authorized local VuPower agent prior to removing the cover of the unit. Standard unit testing and inspections are designed to be performed using the front panel output terminals. If there is a need to use the rear panel output terminals, please review the "Rear Panel Output Terminal Connection Guide" on page 10, prior to use.

Limited Warranty







If it is determined that the damage or failure of this product is not due to consumer's accidents or misuse then the product will be repaired free of charge for a period of one year from the date of the original purchase. If the damage or failure is due to consumer's accidents or misuse or the product warranty expired, then the product will incur repair fee. To obtain warranty service please contact VuPower (www.vupower.com) or authorized local VuPower agent. Shipping and handling fee will be paid by both service requestor and provider.

Safety Guides

Do **NOT** attempt to repair or rebuild this product without the support or approval of manufacturer. If there is any indication of an attempt to repair or rebuild this product without the support or approval of the manufacturer, then the consumer's safety and performance of this product will not be guaranteed by the manufacturer and the sole responsibility will be on the purchaser.

Safety Symbols

The user must operate this product with sufficient caution to avoid electrical shock and protect from electrical dangers. Carelessness usage can cause damage to this equipment. <FYI> Following safety symbols are marked in this user guide and on the equipment for safety.

	Warning
	Earth (Ground) Terminal
	Protective Ground Conductor Terminal must be connected to Earth (Ground)
	In-position of push control
	Out-position of push control
	On (Power Supply)
	Off (Power Supply)

[Contents]

1. Product Information	4
1-1. Overview	4
1-2. Basic Function and Features	4
1-3. Initial Inspection	5
1-4. Environmental Conditions	5
1-5. Cleaning	5
1-6. AC Source Requirement	6
2. Product Configuration & Description	7
2-1. Front Panel	7
2-2. Rear Panel	8
2-3. Display	9
2-4. Output Terminal Connection Guide	9
2-5. Front Panel KEY Functions	11
3. Features	13
3-1. Store	13
3-2. Recall	13
3-3. Error	14
3-4. Setup	14
3-5. Limit Alarm	15
3-6. Over Voltage Protection	16
3-7. Over Current Protection	18
3-8. Pattern Output	20
3-9. Output Status Display Options	22
3-10. Power Fail	23
3-11. Chaging Password	24
3-12. Knob Beep Setup	25
3-13. Restoring to Factory Calibration	26
4. Calibration	27
4-1. Voltage Calibration	28
4-2. Current Calibration	29
5. Error Messages	41
6. Specifications	43
7. Product Warranty	47

1. Product Information

1. Product Information.

1-1. Overview

OXXO™ Series “AK” Model power supply is designed to apply for general purpose. So, its operation is very simple and easy to control with high quality output. It makes your power system application ideal with compact size, which saves your working place by bench-top use as well as standard rack mounting.

	Model	Output Range	Number of Outputs
1	AK1205	[12V x 05A] (60W)	Single Output
2	AK1810	[18V x 10A] (180W)	
3	AK3010	[30V x 10A] (300W)	
4	AK3003	[30V x 03A] (90W)	
5	AK3005	[30V x 05A] (150W)	
6	AK6003	[60V x 03A] (180W)	
7	AK1205D	[12V x 5A] * 2 (120W)	Dual Output
8	AK3003D	[30V x 3A] * 2 (180W)	
9	AK3005D	[30V x 5A] * 2 (300W)	
10	AK6003D	[60V x 3A] * 2 (360W)	

1-2. Basic Function and Features

- Jog Shuttle turns in an increment of 1mV/1mA for output setting (*units with more than 60V output are exceptional)
- User preferred output status display settings
- Setup limit allows voltage and current limit settings and CV/CC with automatic crossover
- Alarm feature during operational mode changes
- Front panel control panel lock
- Easy and convenient calibration and setup
- Power fail feature recalls last settings for repetitive operation convenience
- 10 output status memory per channel
- Output pattern feature
- Terminal sensing feature allows wire error correction
- Front and rear panel output options
- OVP, OCP
- Isolated channel operation (*applies to dual output models only)
- Output channel status readout displayed on 64x128 Graphic Blue Backlight LCD
- Per channel output link feature (*applies to dual output models only)

1-3. Initial Inspection

- Prior to shipment of this power supply was inspected and found free of mechanical or electrical defects from the factory. Upon unpacking of the power supply, inspect for any damage, which may have occurred in transit. Initial inspection should confirm that there is no exterior damage to the power supply such as broken knobs or connectors and that the front panel and display panels are not scratched or cracked. Keep all packing material until the inspection has been completed. If damage is detected, file a claim with carrier immediately and notify VuPOWER(www.vupower.com) or authorized service facility nearest you.
- This User Guide & Power Cable is included in the package.
- Product Warranty is at the end of this User Guide. Please record the 'Product Series', 'Model Name', 'Purchased Date', 'Purchased From', and 'Serial Number', for future use.

1-4. Environmental Conditions

- OXXO™ Series "AK" Model power supply safety approval applies to the following operating conditions:
 - Ambient temperature: 0°C to 40°C
 - Maximum relative humidity: 80% (no condensation)
 - Altitude: up to 2000m
- OXXO™ Series "AK" Model power supply is cooled by internal fan. Care must be taken to allow unrestricted air space at the front and the rear of the unit for proper cooling of power supply. The air intake is at the side panel ventilation inlets and exhaust is at the rear panel.

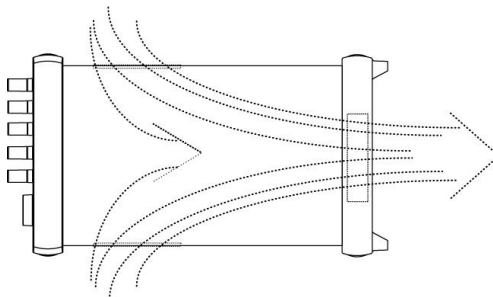

[Air Flow of OXXO™ Series "AK" Model Power Supply]

- When mounting on equipment rack remove the front and rear bumpers and mount with caution. Do not obstruct the air exhaust at the rear panel of the unit.
- Please operate this power supply in an environment with no humidity and vibrations.

1-5. Cleaning

- To prolong the life of OXXO™ Series "AK" Model power supply periodic cleaning is necessary.
- To clean, disconnect the unit from the AC supply and allow 60 seconds for discharging internal voltage.
- Exterior panels should be cleaned with a mild solution of non-alcoholic detergent and water applied onto a soft cloth.
- Internal cleaning should be done by removing the cover and blowing away the dust in the heat sink and the cooling fan. Use low pressure compressed air to blow dust from the unit. Using sharp metal objects to clean the dust is not recommended due to possibility of causing damage to the unit.

1. Product Information.

1-6. AC Source Requirement

OXXO™ Series “AK” Model power supply is designed to operate from a nominal AC 220V/47–63Hz single phase. If the unit is used in other countries with different voltage and frequency rating than the specifications on the rear panel of the unit, then the built-in input source circuitry must be modified. In this case, contact VuPOWER(www.vupower.com) for support

○ Changing AC Source Requirement

1. Remove the cover, then locate the “AC Source Alteration Circuit Board” (see diagram below), and remove it from the slot.
2. Find the correct AC source and insert it back into the slot in the direction of the arrow indicated in front of selected AC source rating

Example of changing AC Source Alteration Circuit Board

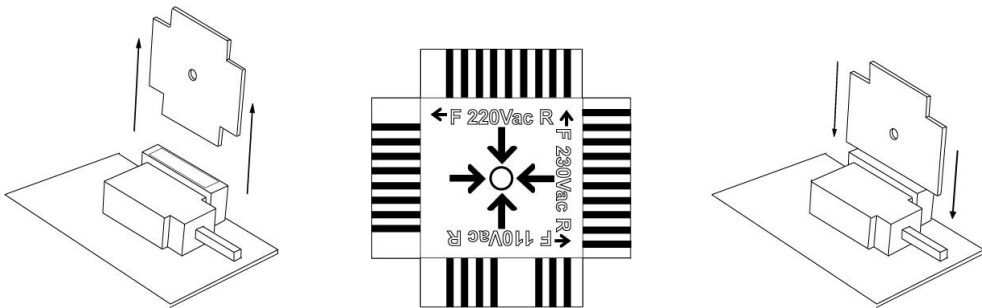

[AC Source Alteration Circuit Board]

○ Replacing the Fuse

Unplug the power cord then remove the fuse holder located above the AC cord socket. Replace with fuse with capacity of ~250V 6.3A

Replacing the Fuse



[Replacing the Fuse]

Warning

Make sure to unplug the power cord prior to changing the AC Source Alteration Circuit Board or the fuse.

2. Product Configuration & Description

2-1. Front Panel

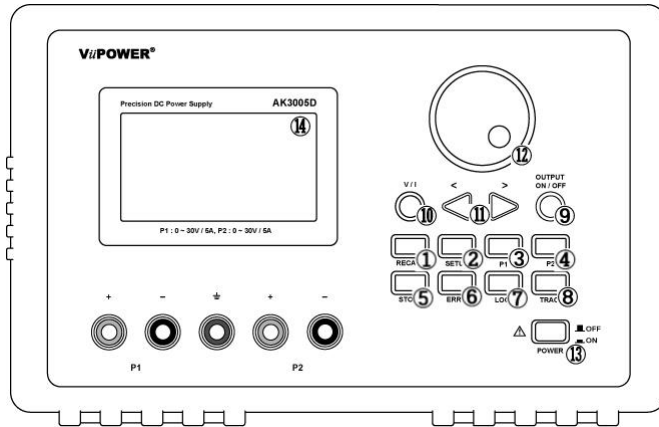

[Dual Output Model Front Panel Configuration]

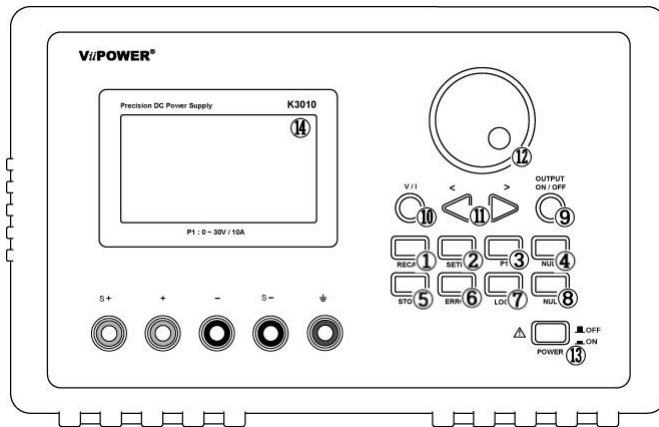

[Single Output Model Front Panel Configuration]

- | | |
|--|--|
| ① Recall: recalls and executes stored values | ⑧ Track: channel link-on / off (*dual output models)
Null (*single output models) |
| ② Setup: Setup Menu | ⑨ Output On/Off: DC output On / Off |
| ③ P1: P1 channel selection | ⑩ V / I: selection between voltage / current |
| ④ P2: P2 channel selection (*dual output models)
Null (*single output models) | ⑪ < , >: moves cursor |
| ⑤ Store: saves output status | ⑫ Jog Shuttle Knob: fine value adjustment |
| ⑥ Error: used to check error message / also used to cancel
Setup Menu | ⑬ Power: switches unit On / Off |
| ⑦ Lock: lock-in / lock-out for front panel control keys | ⑭ Display Panel: indicates output value and operation
status |

2. Product Configuration and Description

2-2. Rear Panel

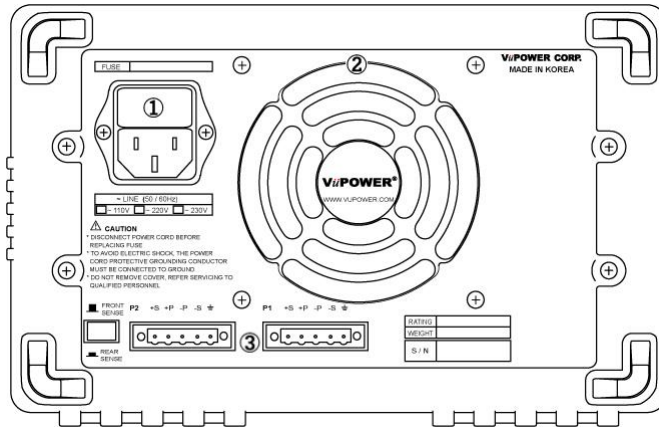

[Dual Output Model Rear Panel Configuration]

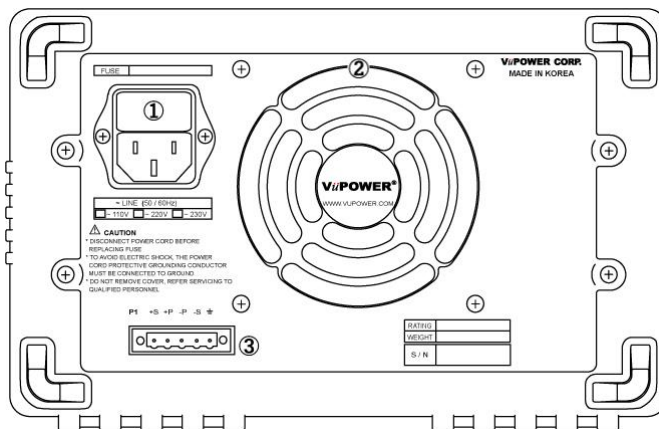

[Single Output Model Rear Panel Configuration]

- ① AC Input Socket With Fuse Holder
- ② DC Colling Fan Outlet
- ③ Rear Panel Output Ports

2. Product Configuration and Description

2-3. Display

ViiPOWER®

ViiPOWER®

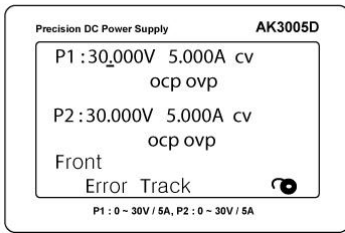

① Dual Output Model

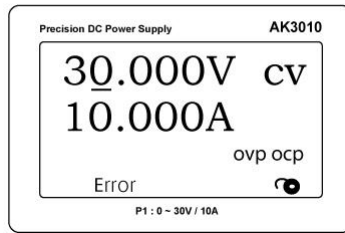

② Single Output Model

[Display Indicators Per Output Status]

- CC : Output (P1 or P2) is operating in Constant Current (CC) mode
- CV : Output (P1 or P2) is operating in Constant Voltage (CV) mode
- OVP : Output (P1 or P2) is operating in Over Voltage Protection (OVP) mode
- OCP : Output (P1 or P2) is operating in Over Current Protection (OCP) mode
- GPIB / RS-232 : Indicating the operation of GPIB / RS-232 remote interface
- Error : Indicate power supply error
- Track : P1 and P2 linked mode
- Lock (Icon) : Indicates front panel control keys locked or unlocked.

2-4. Output Terminal Connection Guide

○ Single Output

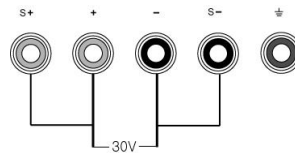

○ Dual Output

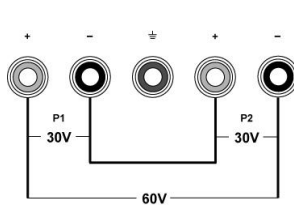
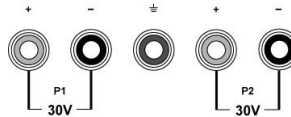

[Series Connection]

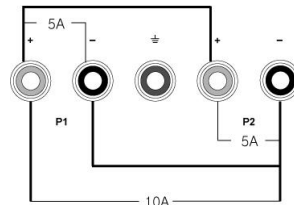

[Parallel Connection]

2. Product Configuration and Description

○ Remote Sensing Connection Guide

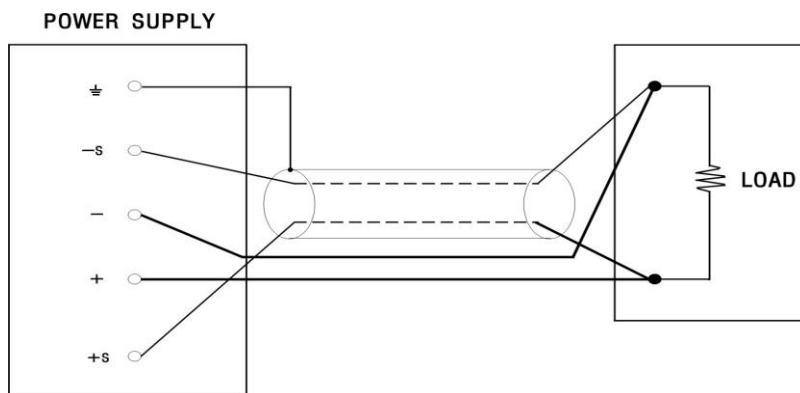

[Remote Sensing Terminal Connection Diagram]

If the load is distant from the power supply, Sensing Terminal and Output Terminal connection (Short Bar) should be removed and the connection should be made as diagram above. This modification eliminates voltage error due to the lengthy output cables.

Remote Voltage Sensing is available on all front and rear output ports for single output models. For the dual output models, remote voltage sensing is available by rear output ports only (use front/rear knob). If the front output ports are used, then the rear output connections should be removed and vice versa for rear output ports as well.

○ Rear Output Terminal Connection Guide

If the rear outputs are used make sure to remove the front connections (Short Bar) then connect to Sensing Terminal.

For dual output models, use the 'Front/Rear Selection Switch' to select rear output (The status of the switch should be indicated on the display panel).

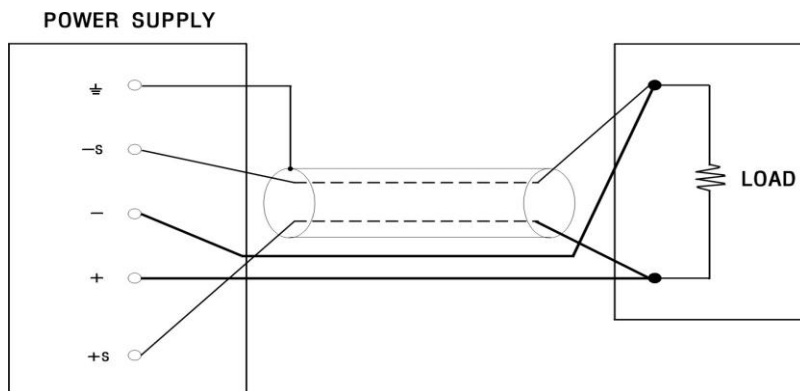

[Rear Output Terminal Connection Diagram]

2-5. Front Panel Key Functions

○ Function Key

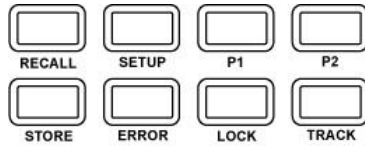

Function Key



To recall stored values.



To setup new configuration.



To select P1 output port.



To select P2 output port.



To store output status / from Setup Menu, to execute or save.



In case of an error, it will show error code.

Please refer to “Error Code” for description of error codes.

From Setup Menu, “ERROR” can be used as Cancel.



To enable/disable lock on function keys on the front panel.

When lock is enabled, lock icon will appear on the display panel.

To disable lock, push “LOCK” button again and an unlocked icon will appear on the display panel. During lock enabled operation, “Output On/Off” button will function only once to allow sudden stop of output.



To obtain equal output voltage from both P1 and P2.

Both output terminals P1 and P2 can be linked to operate as one.

When enabled, “Track” will appear on the display panel.

To disable, pushc “TRACK” button again and “Track” will disappear from the display panel.

2. Product Configuration & Description

○ Control Key

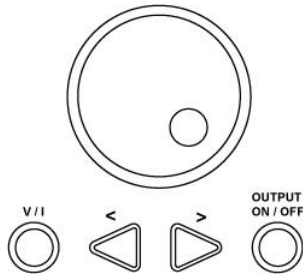

Control Key Diagram

OUTPUT
ON / OFF



Used to immediately stop output voltage (example: to connect new DUT (Device Under Test)). If pushed again, it will continue to output voltage.



Used to change cursor location to voltage or current.



Used to increase or decrease value during voltage or current selection.





Jog Shuttle is used to increase or decrease value of selected cursor.

3. Features

3-1. Store

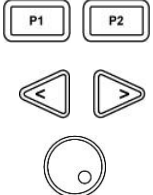

Output values can be stored to be recalled for future use.

Each output port, P1 or P2 can store up to 10 values. When an output terminal is saved, only the voltage and current values are saved but not the status of the setup.

No.	Key Operation	Display Panel	Description
1		P1 06.000V 1.200A P1 06.000V 1.000A Set-Limit: 06.000V 2.000A	Select the output port to use. To change the cursor location, use the arrows. To change the value of selected cursor. The maximum value is as indicated under Set-Limit.
2		Store 01 06.000V 2.000A	This is an example of storing value 06.000V 2.000A in memory 01. When "STORE" button is pressed, the value and the # of memory location (01~10) will appear.
3		01 ~ 10 P1 06.000V 1.000A	Use the Jog Shuttle to select memory location to save the values to. Press "STORE" button again to save. This feature allows each output port P1 or P2 to save up to 10 values.

3-2. Recall

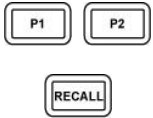
This feature allows saved values to be recalled to change current output value to a different output value.

No.	Key Operation	Display Panel	Description
1		P1 or P2 Recall 01 06.000V 1.000A	Select the output port to use. Press "RECALL" button
2		01 ~ 10, or Pattern output P1 06.000V 1.000A	Use the Jog Shuttle to select the memory location (01~10) and check the saved value. Press "RECALL" button again to recall and use the saved output value.

3. Feature

3-3. Error

During operation if an error occurs, unit will alert the operator by sounding a beep and indicating "Error" on the display panel.



When "ERROR" button is pressed, it will indicate error message for approximately 2 seconds. During this time, each push of the "ERROR" button will display previous error messages in the order of occurrence. Verified error messages will be erased. If all error messages are erased and the unit is operating normally it will indicate "NO ERROR" in the display panel

3-4. Setup



Press "SETUP"



Use arrows or jog shuttle to select:

- SET-Limit
- SET-OVP
- SET-OCV
- SET-Comm
- SET-Pattern
- SET-Display
- SET-Power Fail
- SET-Password
- SET-Knob beep
- SET-Cal-Voltage
- SET-Cal-Current
- SET-Cal-V Recover
- SET-Cal-C Recover

Above settings can be changed by pressing .

During setup user decides to cancel the setting, press .

While the output is turned off, (ex. Output Off) user cannot:

- SET-Cal-Voltage
- SET-Cal-Current
- SET-Cal-V Recover
- SET-Cal-C Recover



Above settings are not in the Setup Menu and the values cannot be changed while the output is turned off.

3-5. Limit Alarm

This feature alerts the user when the power supply reached the current limit set by the user. When the unit exceeds the limit it will automatically change the mode from 'CV' to 'CC', or 'CC' to 'CV' depending on the mode the unit was operating in, and simultaneously sound an alarm and alert the user of the status of the operation.

o Setting the Limit

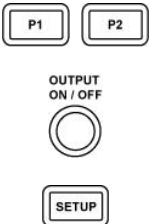
This feature can set the limit of voltage or current to interchange operation mode between CV (Constant Voltage) and CC (Constant Current). If the user selects CV mode operation, the voltage minimum value should be set to zero and the maximum current value should be at its maximum. In this setup, when the operating current output reaches the limit set by the user in CV mode, its present CV mode will automatically change to CC mode to protect any damage to the power supply. If the user selects CC mode operation, the current minimum value should be set to zero and the maximum voltage value should be at its maximum. In this setup, when the operating voltage output reaches the limit set by the user in CC mode, its present CC mode will automatically change to CV mode to protect any damage to the power supply.

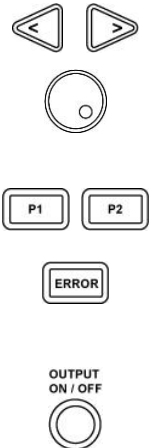
No.	Key Operation	Display Panel	Description
1		P1 or P2 ** OUTPUT OFF ** SET-Limit	Select the output port to use.. Turn off output by pressing "OUTPUT ON / OFF" button. Press "SETUP" button.
2		SET-Limit P1 00.000V 5.000A SET-Limit P1 00.000V 5.000A	In SETUP-Limit, press "SETUP" to change the value. "V/I" button is used to change the cursor between "V" and "I".
3		SET-Limit P1 00.000V 5.000A ** OUTPUT OFF ** P1 00.000V 0.000A	Use the arrows to change the location of the cursor and use the jog shuttle to set the value. Press "P1" or "P2" or "ERROR" button to save the value and exit the setting. The display panel will now indicate "OUTPUT OFF". Press "OUTPUT ON / OFF" button to continue the operation.

3. Feature













3-6. Over Voltage Protection (OVP)

This feature turns-off the output voltage when the voltage exceeds the OVP (Over Voltage Protection) value set by the user, and protects DUT. Over Voltage Protection operates normally within the value range specified in the “Specifications” section of this manual.

[IMPORTANT]

OVP should be set to “OVP OFF” during unit calibration.

○ **OVP Settings**

No.	Key Operation	Display Panel	Description
1	    	P1 or P2 ** OUTPUT OFF ** SET-Limit SET-OVP	Select the output port to use. Turn off output by pressing “OUTPUT ON / OFF” button (recommended). Press “SETUP” button. Use the arrows or jog shuttle to select “SET-OVP”.
2	  	SET-OVP OVP ON / OFF **OUTPUT OFF ** (If “OVP OFF” is selected) **OVP ON** (if “OVP ON” is selected) SET-OVP Level - 00.000V	Press “SETUP” button again. Use the jog shuttle to select ON or OFF Press “STORE” button to save the set value. If “OVP OFF” is selected, it will turn off OVP and exit Setup. If “OVP ON” is selected, user can set the OVP Level.
3	   	SET-OVP Level - 00.000V ** OUTPUT OFF ** OVP P1 00.000V 0.000A OVP	Use the arrows to change the location of the cursor and use the jog shuttle to set the value. Press the “STORE” button. It will save the set value and exit Setup. If OVP is on it will indicate “OVP” in the display panel. Press “OUTPUT ON / OFF” button again to continue use.

○ **OVP Occurrence**



Upon detection of an Over Voltage condition, the power supply output will shut down. During this time, “**OVP**” on the display panel will disappear and “**OVP OCCURRED...**” will appear.

○ **OVP Cancellation**

During OVP occurrence, display panel will show “**OVP OCCURRED...**” and output will shutdown. If the user wishes to turn on the output, OVP must be cancelled. In order to cancel OVP please follow the following instructions.

[IMPORTANT]

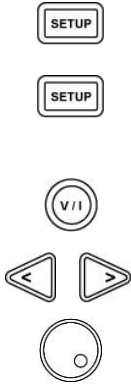
For the protection of DUT, remove the terminal connections during OVP cancellation.

No.	Key Operation	Display Panel	Description
1		OVP OCCURRED...	Indicates OVP occurrence.
2		SET-Limit SET-Limit P1 10.000V 5.000A SET-Limit P1 09.000V 5.000A	Press the “SETUP” button. Press the “SETUP” button again and select “SETUP-LIMIT”. Move the cursor to voltage. Use the arrows to change the location of the cursor and use the jog shuttle to set the value. Limit value must be 1V less than OVP set voltage (ex. If OVP limit was originally set to 10V then the new limit should be set at 9V or less, otherwise it will remain at OVP occurrence status).
3		OVP CLEAR... (2 seconds later) ** OUTPUT OFF ** OVP P1 00.000V 0.000A OVP	Set the new limit and press the applicable PORT or “ERROR” button to save and exit the setup. Now, OVP will cancel and “OVP CLEAR...” will appear on the display panel for 2 seconds, then the output will be turned off. Display panel will indicate “OVP”. Press “OUTPUT ON / OFF” button again to continue use.

3. Features













3-7. Over Current Protection (OCP)

This feature turns off the output when the current exceeds the OCP (Over Current Protection) value set by the user, and protects Load (DUT) connected to the output terminals. Over Current Protection operates normally within the value range specified in the “Specifications” section of this manual.

[IMPORTANT]

OCP should be set to “OCP OFF” during unit calibration.

○ **OCP Settings**

No.	Key Operation	Display Panel	Description
1	    	P1 or P2 ** OUTPUT OFF ** SET-Limit SET-OCP	Select the output port to use. Turn off output by pressing “OUTPUT ON / OFF” button (recommended). Press “SETUP” button. Use the arrows or jog shuttle to select “SET-OCP”.
2	  	SET-OCP OCP ON / OFF **OUTPUT OFF ** (If “OCP OFF” is selected) **OCP ON** (If “OCP ON” is selected) SET-OCP Level - 00.000A	Press “SETUP” button again. Use the jog shuttle to select ON or OFF Press “STORE” button to save the set value. If “OCP OFF” is selected, it will turn off OCP and exit Setup. If “OCP ON” is selected, user can set the OVP Level.
3	   	SET-OCP Level - 00.000V ** OUTPUT OFF ** OCP P1 00.000V 0.000A OCP	Use the arrows to change the location of the cursor and use the jog shuttle to set the value. Press the “STORE” button. It will save the set value and exit Setup. If OCP is on, it will indicate “OCP” in the display panel. Press “OUTPUT ON / OFF” button again to continue use.

○ **OCP Occurrence**



Upon detection of an Over Current condition, the power supply output will shut down. During this time, “OCP” on the display panel will disappear and “OCP OCCURRED...” will appear.

○ **OCP Cancellation**

During OCP occurrence, display panel will show “OCP OCCURRED...” and output will shutdown. If the user wishes to turn on the output, OCP must be cancelled. In order to cancel OCP please follow the following instructions.

[IMPORTANT]

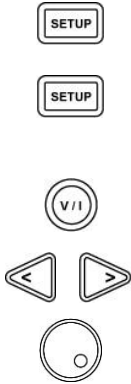
For the protection of DUT, remove the terminal connections during OCP cancellation..

No.	Key Operation	Display Panel	Description
1		OCP OCCURRED...	Indicates OCP occurrence.
2		SET-Limit SET-Limit P1 10.000V 5.000A SET-Limit P1 10.000V 4.900A	Press the “SETUP” button. Press the “SETUP” button again and select “SETUP-LIMIT”. Move the cursor to voltage. Use the arrows to change the location of the cursor and use the jog shuttle to set the value. Limit value must be 0.1A less than OCP set current (ex. If OCP limit was originally set to 5.0A then the new limit should be set at 4.9A or less, otherwise it will remain at OCP occurrence status).
3		OCP CLEAR... (2 seconds later) ** OUTPUT OFF ** OCP P1 00.000V 0.000A OCP	Set the new limit and press the applicable PORT or “ERROR” button to save and exit the setup. Now, OCP will cancel and “OCP CLEAR...” will appear on the display panel for 2 seconds, then the output will be turned off. Display panel will indicate “OCP”. Press “OUTPUT ON/OFF” button again to continue use.

3. Features

3-8. Pattern Output

The terms used in this feature are defined as follows:

1. **Pattern Output:** continuous output of user set voltage over user set period of time.
2. **Steps:** duration of continuous user set voltage output (minimum 1 second to maximum 5 hours). The first output voltage is called, "Step 1". When the user programs patterns from the front panel, total of 10 "Steps" can be set. If additional "Steps" are needed, use remote connection feature.
3. **Repeats:** determine the number of repeated output of total "Steps" programmed by the user. For example, if there are five "Steps" set by the user and the user wants it to be repeated six times, then the unit will continuously output until it completes the cycle of Step 1 thru Step 5, six times.



[IMPORTANT]

Prior to operating Pattern Output, make sure to check Pattern Output Condition Settings. Pattern Output can only change voltage limit values. Therefore, voltage limit values should be set to meet specifications of DUT (Device Under Test).

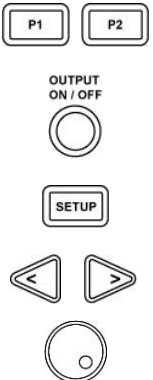
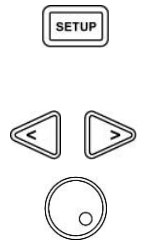

○ Pattern Output Condition Settings

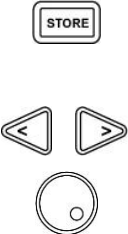
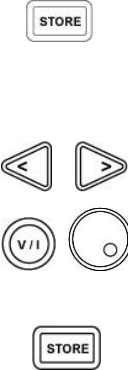
To program Pattern Output number of Steps (1~10) and the number of times required to repeat (maximum of 100 times allowed), voltage of each Steps (1~10), and the duration of required continuous output are necessary. If there is correction to be made during Pattern Output programming, press "ERROR" button to go back to the previous step.

No.	Key Operation	Display Panel	Description
1		P1 or P2 ** OUTPUT OFF ** SET-LIMIT SET-PATTERN	Select the port to set Pattern Output Condition. Turn off output by pressing "OUTPUT ON / OFF" button (recommended). Press "SETUP" button. Use the arrows or jog shuttle to select "SET-PATTERN". Press "SETUP" button again.
2		SET-PATTERN Step - 01 to 10 SET-PATTERN Step - 01 to 10	This is where the user decides the number of output "Steps". Use the arrows to change the location of the cursor and use the jog shuttle to set the value.

3		<p>SET-Pattern Repeat – 001</p> <p>SET-Pattern Repeat – 001</p>	<p>Press “STORE” button to save number of output “Steps” then set the number of repeats.</p> <p>Use the arrows to change the location of the cursor and use the jog shuttle to set the value.</p>
4		<p>SET-Pattern 01 00.000V 00000S</p> <p>SET-Pattern 01 00.000V 00000S</p>	<p>Press “STORE” button again to save number of repeats, then, set the voltage and duration of “Step 1”. Duration is set in increments of seconds.</p> <p>Use arrows and “V/I” button to change cursor location, and use the jog shuttle to set voltage and duration of each “Step”.</p> <p>Press “STORE” button to save and repeat this process for all “Steps” to be programmed.</p>
5		<p>** OUTPUT OFF **</p> <p>P1 00.000V 0.000A</p>	<p>When all “Steps” are programmed press “STORE” button to save and exit from Setup.</p> <p>Press “OUTPUT ON/OFF” button again to continue use.</p>

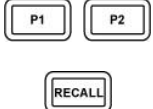
○ Pattern output Operation

No.	Key Operation	Display Panel	Description
1		<p>P1 or P2</p> <p>Recall 01</p> <p>06.000V 1.000A</p>	<p>Select the output port to use.</p> <p>Press “RECALL” button.</p> <p>User can now select the “Pattern Output” to use.</p>
2		<p>Recall Pattern output</p> <p>P1 06.000V 1.000A</p> <p>Step : 01</p>	<p>Use the jog shuttle to select any saved “Pattern Output”.</p> <p>Once selection has been made, press “RECALL” to execute.</p>

OUTPUT
ON / OFF



Use  button to shut down output during operation.

When the “Pattern Output” completes its cycle the display panel will indicate “OUTPUT OFF”.

3. Feature

3-9. Output Status Display Options

User can select to operate OXXO™ Series “AK” Model power supply by “Entered” (user programmed) data or by the “Measured” (unit’s internal measurement) data mode. Either selection will become the operating standard.

Entered Value









When the “Entered” (user programmed data) is selected to be the operating standard, and the power supply is operating in CV (Constant Voltage) mode, voltage is set by the “Entered” (user programmed) data, and the current is set by the “Measured” (unit’s internal measurement) data. If the power supply is operating in CC (Constant Current) mode, current is set by the “Entered” (user programmed) data, and the voltage is set by the “Measured” (unit’s internal measurement) data.

Measured Value

When the “Measured (internal measurement) data is selected to be the operating standard, and whether the power supply is operating in CV or CC mode, voltage and current are set by the “Measured” (unit’s internal measurement) data.

The factory default operating standard is set to “Entered” (user programmed) data.

○ Condition Settings

No.	Key Operation	Display Panel	Description
1	   	** OUTPUT OFF ** SET-Limit SET-Display	Turn off output by pressing “OUTPUT ON / OFF” button (recommended) Press “SETUP” button. Use the arrows or the jog shuttle to select “SET-DISPLAY”.
2	 	SET-Display Entered or Measured	Press “SETUP”. Use the jog shuttle to select “Entered” or “Measured” as operating standard.
3	 	** OUTPUT OFF ** P1 00.000V 0.000A	Press “STORE” button to save the operating standard and exit from Setup. Press “OUTPUT ON / OFF” button to continue the operation.

3-10. Power Fail



"SET-POWER FAIL" saves the last output status when the power supply is shut down.

"POWER FAIL ON" initializes power supply with last saved output status during booting process.

"Power Fail OFF" initializes power supply as "OUTPUT OFF" status during booting process.

[IMPORTANT]

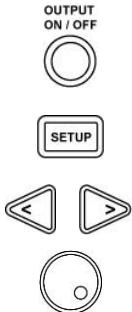

This feature only applies to output continued for 10 seconds or more.

No.	Key Operation	Display Panel	Description
1		<p>** OUTPUT OFF **</p> <p>SET-Limit</p> <p>SET-POWER FAIL</p>	<p>Turn off output by pressing "OUTPUT ON / OFF" button (recommended).</p> <p>Press the "SETUP" button.</p> <p>Use the arrows or jog shuttle to select "SET-POWER FAIL".</p>
2		<p>SET-POWER FAIL</p> <p>POWER FAIL ON or OFF</p>	<p>Press the "SETUP" button again.</p> <p>Use jog shuttle to select "ON" or "OFF".</p>
3		<p>** OUTPUT OFF **</p> <p>P1 00.000V 0.000A</p>	<p>Press "STORE" to save current setting and exit from Setup.</p> <p>Press "OUTPUT ON / OFF" button to continue use.</p>

3. Feature

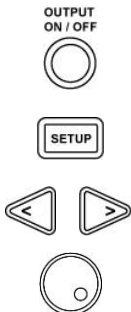
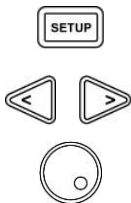
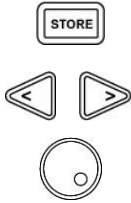

3-11. Changing Password

To protect calibration values user must enter password prior to using Calibration Menu. Passwords are in 4 digit numeric format. The factory default password is 1234.

No.	Key Operation	Display Panel	Description
1		<p>** OUTPUT OFF **</p> <p>SET-LIMIT</p> <p>SET-PASSWORD</p>	<p>Turn off out put by pressing “OUTPUT ON / OFF” button (recommended).</p> <p>Press the “SETUP” button.</p> <p>Use the arrows or the jog shuttle to select “SET-PASSWORD”.</p>
2		<p>SET-PASSWORD</p> <p>Password: ****</p> <p>1 2 3 4</p>	<p>Press the “SETUP” button again.</p> <p>To enter a new password, user must verify previously entered password. Use the arrows to change the location of the cursor and use the jog shuttle to change the value of each digit. If this is the first time setting the password, enter the factory default password, 1234.</p>
3		<p>SET-Password</p> <p>New Psw ****</p> <p>(ex. 4321)</p>	<p>Press the “STORE” button.</p> <p>Now enter the new 4 digit password using the arrows and jog shuttle</p>
4		<p>** OUTPUT OFF **</p> <p>P1 00.000V 0.000A</p>	<p>Press the “STORE” button to save the new password and exit the Setup.</p> <p>Press “OUTPUT ON / OFF” button again to continue use.</p>

3-12. Knob Beep Setup

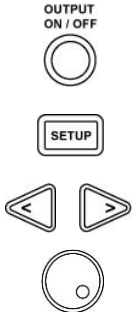
User can select to have beep sound enabled or disabled for jog shuttle. This feature is only applicable for jog shuttle. When “Knob Beep ON” is selected, sound will be heard when jog shuttle is turned and when “Knob Beep OFF” is selected, there will be no sound.

No.	Key Operation	Display Panel	Description
1		<p>** OUTPUT OFF **</p> <p>SET-Limit</p> <p>SET-Knob Beep</p>	<p>Turn off output by pressing “OUTPUT ON / OFF” button (recommended).</p> <p>Press the “SETUP” button.</p> <p>Use the arrows or the jog shuttle to select “SET-Knob Beep”.</p>
2		<p>SET-Knob Beep</p> <p>Knob Beep ON or OFF</p>	<p>Press the “SETUP” button again.</p> <p>Use the jog shuttle to select “ON” or “OFF”.</p>
3		<p>** OUTPUT OFF **</p> <p>P1 00.000V 0.000A</p>	<p>Press the “STORE” button to save and exit from Setup</p> <p>Press “OUTPUT ON / OFF” button again to continue use.</p>

3. Features



3-13. Calibration Recover

This feature restores the Calibration status to factory calibration.

[IMPORTANT]

This feature CAN NOT replace user's modification

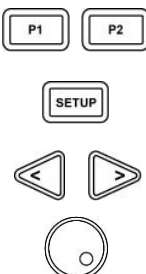
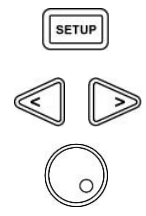
○ **Voltage Recover**

No.	Key Operation	Display Panel	Description
1		P1 or P2 SET-Limit SET-Cal_V Recover	Select desired output port. Press "SETUP" button. Use the arrows or the jog shuttle to select. "SET-Cal_V Recover"
2		SET-Cal_V Recover Password **** ※ Factory default - 1 2 3 4	Press "SETUP" button. Please enter 4 digit Password. Use the arrows to move cursor. Use the jog shuttle to select the number for the password.
3		Cal-V recovered P1 00.000V 0.000A	Press "SETUP" button. After 2 seconds, you will see Cal-V recovered sign with formatting of Voltage adjustment. You will exit from Setup mode.

○ **Current Recover**

It is similar to voltage recover procedure.

Follow Voltage recover step 1 up until you reach Setup Menu, and choose "SET-Cal_C Recover" Menu.

4. Calibration

[Warning]

Device calibration is recommended to restore by certified technicians.

Improper restoration may cause serious error in voltage and current out put.

“OVP” and “OCP” should be set to “OFF” during unit calibration.

Please do not attempt restore load or disassemble the device during electric current adjustment.

It is strongly recommended restore the voltage and current every six months.

Device calibration may be adjusted from device screen and remote control.

VüPower recommends adjustments through the device.

In order to restore remote devices refer COMMAND in following page, “6. Communication Interface Protocol” to adjust through remote controller.

It is possible to adjust more than one output if the product has Dual Output.

Please refer instruction following.

1. Calibrate the device after 1 hour of operation in room temperature 25+/-5°C.
2. Voltage Calibration: Use specific measuring device that can monitor higher than 0.1 mV.
3. Current Calibration: Use specific measuring device such as ampere meter or shunt resistor that can monitor higher than 0.1mA.

Monitor output current after connecting load and ampere meter.

After current calibration starts, you must see “CC” sign. If you see “CV” sign on the screen, you must check load capacity or connection.

Normalized load resistance must meet stronger resistance value than the number that Power Supply’s output can operate in CC Mode.

VüPower recommends device with high temperature resistance.

[Examples of normalized load resistance in calibration]















30V/3A: ≤ 9.5 ohm / 100W or higher

30V/5A: ≤ 5.5 ohm / 150W or higher















30V/10A: ≤ 2.7 ohm / 300W or higher

4. Calibration

4-1. Voltage Calibration

Order	Selection	Screen Display	Description
1	   	P1 or P2 SET-Limit SET-Cal_Voltage	Select desired output port. Press "SETUP" button. Please check whether OVP or OCP function is turned <u>OFF</u> . Use Arrow sign or Jog Shuttle to choose SET-Cal_Voltage.
2	  	SET-Cal_Voltage Password: **** 0 ※ Factory default - 1 2 3 4	Press "SETUP" button. Please enter 4 digit Password. Use the arrows to move cursor. Use the jog shuttle to select the number for the password.
3	  	SET- Cal_Voltage Vlo – 00.000V	By pressing STORE button, you will be able to adjust lowest voltage level. Enter 3 decimal point voltage value that DVM shows. Use arrow button to move cursor. Use Jog Shuttle to select the number.
4	  	SET- Cal_Voltage Wait For AD Cal SET- Cal_Voltage Vhi – 30.000V	Press STORE Button to save the lowest voltage level. After 2 seconds, the screen will automatically lead you to the highest voltage level selection. Enter 3 decimal point voltage value that DVM shows. Use arrow button to move cursor. Use Jog Shuttle to select the number.
5		Wait For AD Cal Complete P1 00.000V 0.000A	Press STORE button to save the adjusted value After 2 seconds, the screen will show completed sign with the message "Wait For AD Cal"

4-2. Current Calibration

Order	Selection	Screen Display	Description
1	   	P1 or P2 SET-Limit SET-CAL_Current	Select desired output port. Press "SETUP" button. Please check whether OVP or OCP function is turned <u>OFF</u> . Use Arrow sign or Jog Shuttle to choose SET-Cal_Current.
2	  	SET-CAL_Current Password **** 0 ※ Factory default - 1 2 3 4	Press "SETUP" button. Please enter 4 digit Password. Use the arrows to move cursor. Use the jog shuttle to select the number for the password.
3	  	SET-CAL_Current Alo – 0.000A	By pressing "STORE" button, you will be able to restore lowest current level. Enter 3 decimal point current value that ampere meter shows. Use the arrows to move cursor. Use the jog shuttle to select the number.
4	  	SET-CAL_Current Wait For AD Cal SET-CAL_Current Ahi – 5.000A	Press "STORE" Button to save the lowest current level. After 2 seconds, the screen will automatically lead you to the highest current level selection. Enter 3 decimal point voltage value that ampere meter shows. Use the arrows to move cursor. Use the jog shuttle to select the number.
5		Wait For AD Cal Complete P1 00.000V 0.000A	Press "STORE" button to save the restored value The unit will be restored after 2 seconds.

5. Error Messages

When you hear warning signal (beep) with error message on the screen, the device may have more than one error.

Error Type	Error Messages and Description
1	Cooling Fan Error It is either the electricity is not supplied into cooling fan or the cooling fan is malfunctioning.

6. Specifications

6. Specifications

The following specification of this device is measured 1 hour after operation in room temperature ($25^{\circ}\text{C} \pm 5^{\circ}\text{C}$).

○ Settings of Out Put Range

Voltage: 1mV (Only when out put exceeds 60V; Voltage: 10mV)

Current: 1mA

○ Programming Accuracy (@ $25^{\circ}\text{C} \pm 5^{\circ}\text{C}$), \pm (% of output + offset)

Model	CH.	Output Parameter		Voltage	Current
		Voltage	Current		
AK1205	P1	0~12V	0~5A	0.03%+15mV	0.1%+05mA
AK1810	P1	0~18V	0~10A	0.05%+15mV	0.1%+10mA
AK3010	P1	0~30V	0~10A	0.05%+15mV	0.1%+10mA
AK3003	P1	0~30V	0~3A	0.03%+15mV	0.1%+5mA
AK3005	P1	0~30V	0~5A	0.03%+15mV	0.1%+5mA
AK6003	P1	0~60V	0~3A	0.05%+20mV	0.1%+5mA
AK1205D	P1	0~12V	0~5A	0.03%+15mV	0.1%+5mA
	P2	0~12V	0~5A	0.10%+25mV	0.1%+10mA
AK3003D	P1	0~30V	0~3A	0.03%+15mV	0.1%+5mA
	P2	0~30V	0~3A	0.10%+25mV	0.1%+10mA
AK3005D	P1	0~30V	0~5A	0.03%+15mV	0.1%+5mA
	P2	0~30V	0~5A	0.10%+25mV	0.1%+10mA
AK6003D	P1	0~60V	0~3A	0.05%+20mV	0.1%+5mA
	P2	0~60V	0~3A	0.10%+25mV	0.1%+10mA

○ Readback Accuracy (@ $25^{\circ}\text{C} \pm 5^{\circ}\text{C}$), \pm (% of output + offset)

Model	CH.	Output Parameter		Voltage	Current
		Voltage	Current		
AK1205	P1	0~12V	0~5A	0.03%+10mV	0.1%+3mA
AK1810	P1	0~18V	0~10A	0.05%+12mV	0.1%+7mA
AK3010	P1	0~30V	0~10A	0.05%+12mV	0.1%+7mA
AK3003	P1	0~30V	0~3A	0.03%+10mV	0.1%+3mA
AK3005	P1	0~30V	0~5A	0.03%+10mV	0.1%+3mA
AK6003	P1	0~60V	0~3A	0.05%+15mV	0.1%+3mA
AK1205D	P1	0~12V	0~5A	0.03%+10mV	0.1%+3mA
	P2	0~12V	0~5A	0.10%+20mV	0.1%+7mA
AK3003D	P1	0~30V	0~3A	0.03%+10mV	0.1%+3mA
	P2	0~30V	0~3A	0.10%+20mV	0.1%+7mA
AK3005D	P1	0~30V	0~5A	0.03%+10mV	0.1%+3mA
	P2	0~30V	0~5A	0.10%+20mV	0.1%+7mA
AK6003D	P1	0~60V	0~3A	0.05%+15mV	0.1%+3mA
	P2	0~60V	0~3A	0.10%+20mV	0.1%+7mA

6. Specifications

○ Ripple and Noise (@ 25°C ± 5°C), (20Hz ~ 20MHz)

Model	CH.	Voltage	Current
AK1205	P1	< 3mVp-p	< 1mArms
AK1810	P1	< 4mVp-p	< 2mArms
AK3010	P1	< 5mVp-p	< 2mArms
AK3003	P1	< 3mVp-p	< 1mArms
AK3005	P1	< 3mVp-p	< 1mArms
AK6003	P1	< 4mVp-p	< 1mArms
AK1205D	P1	< 3mVp-p	< 1mArms
	P2	< 8mVp-p	< 1mArms
AK3003D	P1	< 3mVp-p	< 1mArms
	P2	< 8mVp-p	< 1mArms
AK3005D	P1	< 3mVp-p	< 1mArms
	P2	< 8mVp-p	< 1mArms
AK6003D	P1	< 4mVp-p	< 1mArms
	P2	< 8mVp-p	< 1mArms

○ Rising and Falling Time (@ 25°C ± 5°C)

Model	CH.	Full Load		No Load	
		Up	Down	Up	Down
AK1205	P1	< 7msec	< 9msec	< 7msec	< 60msec
AK1810	P1	< 10msec	< 13msec	< 10msec	< 100msec
AK3010	P1	< 12msec	< 15msec	< 12msec	< 110msec
AK3003	P1	< 12msec	< 15msec	< 12msec	< 110msec
AK3005	P1	< 12msec	< 15msec	< 12msec	< 110msec
AK6003	P1	< 16msec	< 20msec	< 16msec	< 250msec
AK1205D	P1	< 7msec	< 9msec	< 7msec	< 60msec
	P2	< 7msec	< 9msec	< 7msec	< 60msec
AK3003D	P1	< 12msec	< 15msec	< 12msec	< 110msec
	P2	< 12msec	< 15msec	< 12msec	< 110msec
AK3005D	P1	< 12msec	< 15msec	< 12msec	< 110msec
	P2	< 12msec	< 15msec	< 12msec	< 110msec
AK6003D	P1	< 15msec	< 20msec	< 15msec	< 250msec
	P2	< 15msec	< 20msec	< 15msec	< 250msec

○ Transient Response Time

A **transient response** or **natural response** is the portion of the response that approaches zero after a sufficiently long time. Transient Response Time in this unit is within 50 μ s.

6. Specifications

○ Load Regulation (@ 25°C ± 5°C), ±(% of output + offset)

Model	CH.	Voltage	Current
AK1205	P1	0.01%+2mV	0.01%+0.2mA
AK1810	P1	0.01%+2mV	0.01%+0.2mA
AK3010	P1	0.01%+3mV	0.01%+0.2mA
AK3003	P1	0.01%+2mV	0.01%+0.2mA
AK3005	P1	0.01%+2mV	0.01%+0.2mA
AK6003	P1	0.01%+2mV	0.02%+0.3mA
AK1205D	P1	0.01%+2mV	0.01%+0.2mA
	P2	0.01%+2mV	0.01%+0.2mA
AK3003D	P1	0.01%+2mV	0.01%+0.2mA
	P2	0.01%+2mV	0.01%+0.2mA
AK3005D	P1	0.01%+2mV	0.01%+0.2mA
	P2	0.01%+2mV	0.01%+0.2mA
AK6003D	P1	0.01%+2mV	0.02%+0.3mA
	P2	0.01%+2mV	0.02%+0.3mA

○ Line Regulation (@ 25°C ± 5°C), ±(% of output + offset)

Model	CH.	Voltage	Current
AK1205	P1	0.01%+2mV	0.01%+0.2mA
AK1810	P1	0.01%+2mV	0.01%+0.2mA
AK3010	P1	0.01%+3mV	0.01%+0.2mA
AK3003	P1	0.01%+2mV	0.01%+0.2mA
AK3005	P1	0.01%+2mV	0.01%+0.2mA
AK6003	P1	0.01%+2mV	0.02%+0.3mA
AK1205D	P1	0.01%+2mV	0.01%+0.2mA
	P2	0.01%+2mV	0.01%+0.2mA
AK3003D	P1	0.01%+2mV	0.01%+0.2mA
	P2	0.01%+2mV	0.01%+0.2mA
AK3005D	P1	0.01%+2mV	0.01%+0.2mA
	P2	0.01%+2mV	0.01%+0.2mA
AK6003D	P1	0.01%+2mV	0.02%+0.3mA
	P2	0.01%+2mV	0.02%+0.3mA

○ Margin of Stability in output ±(% of output + offset)

Voltage : 0.02% + 2mV

Current : 0.1% + 1mA

○ Variation of output in changing temperature ±(% of output + offset)

P1: 0.02% + 3mV / 0.02% + 2mA

P2: 0.02% + 5mV / 0.02% + 2mA

6. Specifications

- **Recommended Adjustment Period**

6 Months

- **AC Input Rating and Net Weight**

Please refer AC input rating from the back of the device.

Model	AC Input Rating	Net Weight
AK1810	450 VA	10.4Kg
AK3010	635 VA	10.4Kg
AK3003	300 VA	8.5Kg
AK3005	390 VA	8.5Kg
AK6003	420 VA	8.5Kg
AK3003D	400 VA	10.4Kg
AK3005D	500 VA	10.4Kg
AK6003D	600 VA	10.4Kg

- **Dimension**

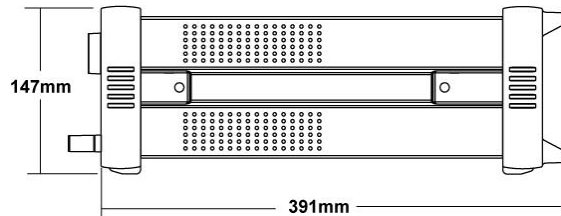
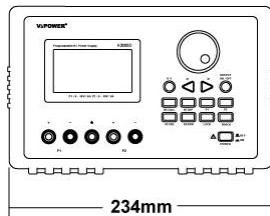

[Including Rubbery Bumper]

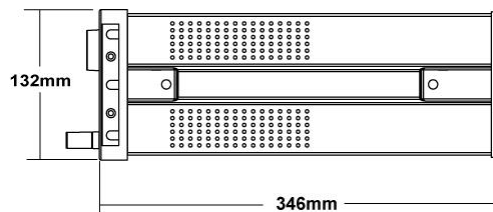
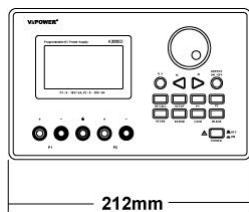

[Excluding Rubbery Bumper]

This unit may be used as Bench-top or attached with 3Ux19" Standard Rack after the removal of rubbery bumper.

Product Warranty

Product Series: OXXO™

Model Name:

Purchased Date:

Purchased From:

Serial Number:

About Product Support

1. VuPOWER warrants all materials, workmanship and proper operation of this product for a period of a year from the original date of purchase. If any defects are found in the materials or workmanship or if the product fails to function properly during the applicable warranty period, VuPOWER, at its option, will repair or replace the product.
2. Service and repairs of OXXO™ Series are to be performed only at an Authorized OXXO™ Service Center. Unauthorized service, repairs, or modifications will void this warranty.
3. To obtain factory-authorized service call VuPOWER at 82+42 934 6928, 9 AM to 5 PM Monday through Friday (Korean Time) to get a Service Request Number. *Product returned without a Service Request Number will be refused.* Ship the product in its original shipping carton, freight prepaid to the authorized service center.
4. VuPOWER warrants all repairs performed for a year or for the remainder of the warranty period. This warranty does not extend to damage resulting from improper installation, misuse, neglect or abuse, or to exterior appearance. This warranty is recognized only if the inspection seals and serial number on the unit have not been defaced or removed.
5. VuPOWER provides additional repair service after the expiration of the limited warranty. For more information, please contact VuPOWER.
6. THE WARRANTY GIVEN ON THIS PAGE IS THE SOLE WARRANTY GIVEN BY VuPOWER AND IS IN LIEU OF ALL OTHER WARRANTIES EXPRESS AND IMPLIED, INCLUDING THE WARRANTIES OF MERCHANTABILITY AND FITNESS FOR A PARTICULAR PURPOSE. THE WARRANTY GIVEN ON THIS PAGE SHALL BE STRICTLY LIMITED IN DURATION TO ONE YEAR FROM THE DATE OF ORIGINAL PURCHASE FROM AN AUTHORIZED VuPOWER DEALER. UPON EXPIRATION OF THE APPLICABLE WARRANTY PERIOD, VuPOWER SHALL HAVE NO FURTHER WARRANTY OBLIGATION OF ANYKIND. VuPOWER SHALL NOT BE LIABLE FOR ANY INCIDENTAL, SPECIAL, OR CONSEQUENTIAL DAMAGES THAT MAY RESULT FROM ANY DEFECT IN THE OXXO™ PRODUCT OR ANY WARRANTY CLAIM.

Suite #504, HanShin S meca, 65, Techno 3-ro, Yuseong-gu, Daejeon, Korea
YuSung-ku, Daejeon 34016, ROK(Republic of Korea)
TEL: 82+42 934 6928
FAX: 82+42 934 6927
URL: <http://www.vupower.com>
e-Mail: sales@vupower.com

VuPOWER